

Features

- Zero Reverse Recovery Current
- Positive Temperature Coefficient
- High-Speed Switching
- Moisture Sensitivity Level 1
- Epoxy Meets UL 94 V-0 Flammability Rating
- Halogen Free Available Upon Request By Adding Suffix "-HF"
- Lead Free Finish/RoHS Compliant(Note 1) ("P" Suffix designates RoHS Compliant. See ordering information)

Benefits

- Temperature-Independent Performance
- Essentially No Switching Loss
- Higher Efficiency
- Reduced EMI
- Reduction of Heat Sink Requirements

Applications

- Switching Power Supply
- Power Factor Correction
- Solar Inverter

Maximum Ratings

- Operating Junction Temperature Range: -55°C to +175°C
- Storage Temperature Range: -55°C to +175°C
- Thermal Resistance: 4.55°C/W Junction to Case

MCC Part Number	Device Marking
SICU0260B	SICU0260B

Peak Repetitive Reverse Voltage	V_{RRM}	650V	
Surge Peak Reverse Voltage	V_{RSM}	650V	
DC Reverse Voltage	V_{DC}	650V	
Average Forward Current	I_F	2A	$T_C=160^\circ\text{C}$
Peak Forward Surge Current	I_{FSM}	22A	$T_C=25^\circ\text{C}$, $t_p=10\text{ms}$, Half Sine Pulse
Repetitive Peak Forward Current	I_{FRM}	13A	$T_C=25^\circ\text{C}$, $t_p=10\text{ms}$, Half Sine Pulse
Power Dissipation	P_D	33W	$T_C=25^\circ\text{C}$

Note:1.High Temperature Solder Exemption Applied, see EU Directive Annex 7a.

Internal Structure:

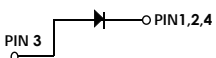

2 Amp Silicon Carbide Schottky Barrier Rectifier 650 Volts

DPAK

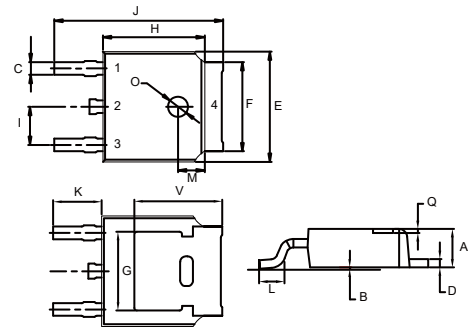

DIM	INCHES		MM		NOTE
	MIN	MAX	MIN	MAX	
A	0.087	0.094	2.20	2.40	
B	0.000	0.005	0.00	0.13	
C	0.026	0.034	0.66	0.86	
D	0.018	0.023	0.46	0.58	
E	0.256	0.264	6.50	6.70	
F	0.201	0.215	5.10	5.46	
G	0.190		4.83		TYP.
H	0.236	0.244	6.00	6.20	
I	0.086	0.094	2.18	2.39	
J	0.386	0.409	9.80	10.40	
K	0.114		2.90		TYP.
L	0.055	0.067	1.40	1.70	
M	0.063		1.60		TYP.
O	0.043	0.051	1.10	1.30	
Q	0.000	0.012	0.00	0.30	
V	0.211		5.35		TYP.

Electrical Characteristics @ 25°C (Unless Otherwise Specified)

Parameter	Symbol	Conditions	Typ.	Max.	Units
Forward Voltage	V_F	$I_F=2A, T_J=25^\circ C$	1.4	1.6	V
		$I_F=2A, T_J=175^\circ C$	1.8	2.5	V
Reverse Leakage Current	I_R	$V_R=650V, T_J=25^\circ C$	1	10	μA
		$V_R=650V, T_J=175^\circ C$	10	50	μA
Total Capacitive Charge	Q_C	$V_R=400V$	5.8		nC
Total capacitance	C	$V_R=0V, f=1MHz$	175		pF
		$V_R=200V, f=1MHz$	10.5		pF
		$V_R=400V, f=1MHz$	8.5		pF
Capacitance Stored Energy	E_C	$V_R=400V$	0.8		μJ

Curve Characteristics

Fig. 1 - Typical Instantaneous Forward Characteristics

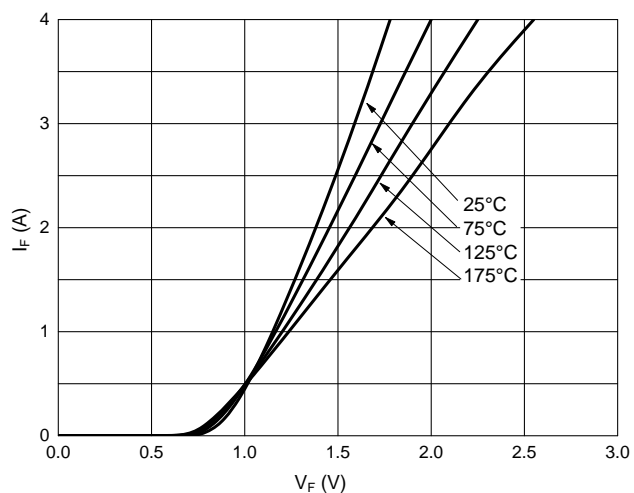
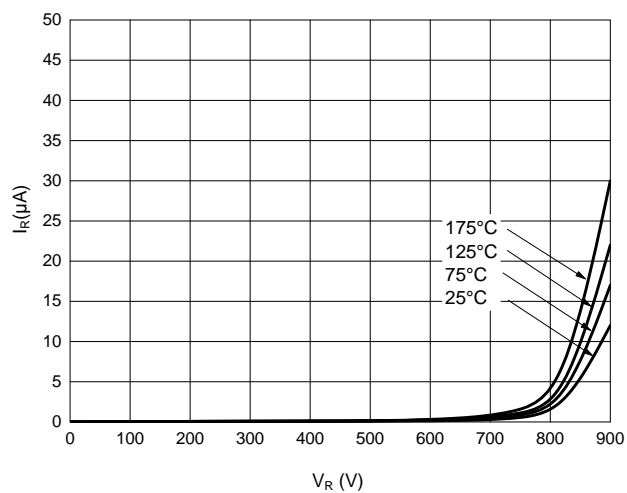

Fig. 2 - Typical Reverse Leakage Characteristics



Curve Characteristics

Fig. 3 - Capacitance vs Reverse Voltage

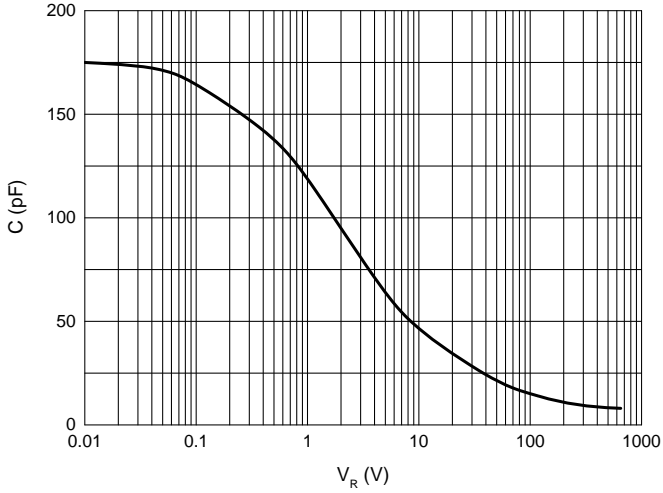

Fig. 4 - Capacitive Charge vs Reverse Voltage

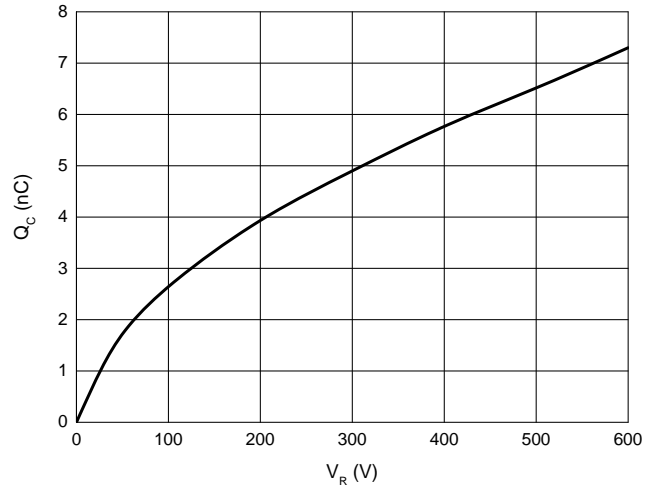

Fig. 5 - Capacitance Stored Energy

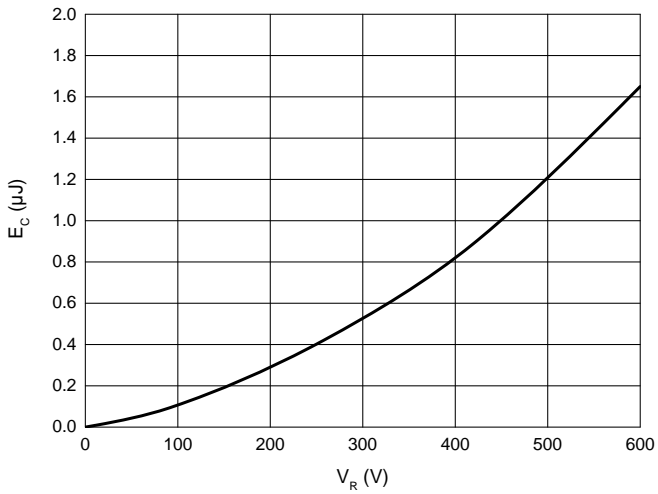

Fig. 6 - Power Derating

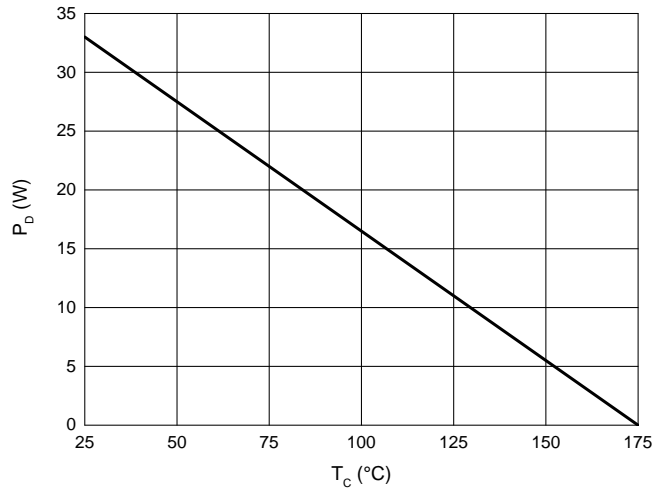

Fig. 7 - Current Derating

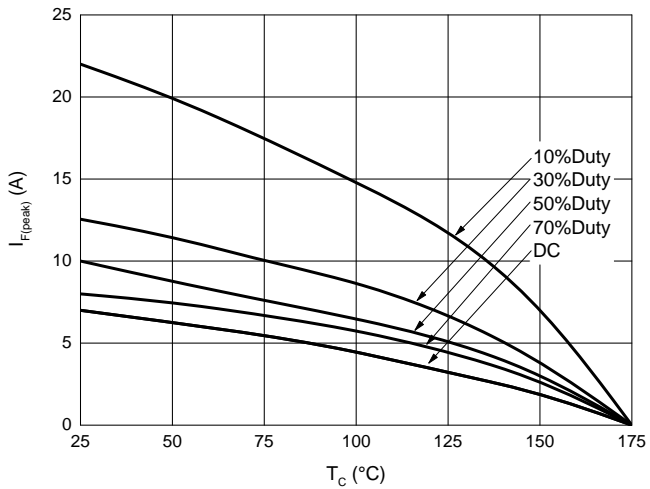
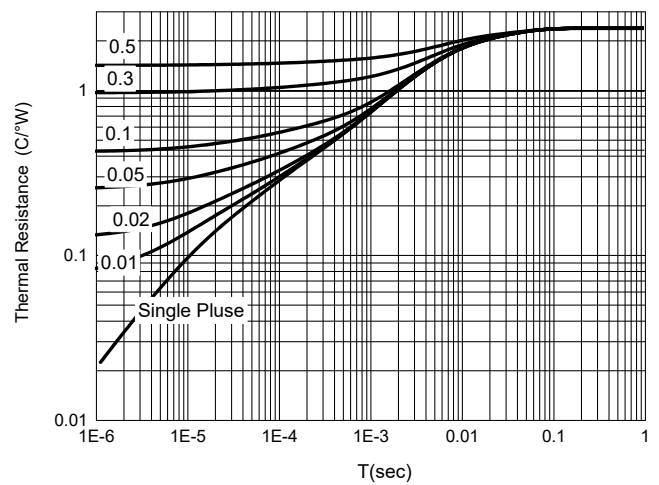

Fig. 8 - Transient Thermal Impedance



Ordering Information

Device	Packing
Part Number-TP	Tape&Reel: 2.5Kpcs/Reel

Note : Adding "-HF" Suffix for Halogen Free, eg. Part Number-TP-HF

*****IMPORTANT NOTICE*****

Micro Commercial Components Corp. reserves the right to make changes without further notice to any product herein to make corrections, modifications , enhancements , improvements , or other changes . **Micro Commercial Components Corp** . does not assume any liability arising out of the application or use of any product described herein; neither does it convey any license under its patent rights ,nor the rights of others . The user of products in such applications shall assume all risks of such use and will agree to hold **Micro Commercial Components Corp** . and all the companies whose products are represented on our website, harmless against all damages. **Micro Commercial Components Corp.** products are sold subject to the general terms and conditions of commercial sale, as published at <https://www.mccsemi.com/Home/TermsAndConditions>.

*****LIFE SUPPORT*****

MCC's products are not authorized for use as critical components in life support devices or systems without the express written approval of Micro Commercial Components Corporation.

*****CUSTOMER AWARENESS*****

Counterfeiting of semiconductor parts is a growing problem in the industry. Micro Commercial Components (MCC) is taking strong measures to protect ourselves and our customers from the proliferation of counterfeit parts. MCC strongly encourages customers to purchase MCC parts either directly from MCC or from Authorized MCC Distributors who are listed by country on our web page cited below. Products customers buy either from MCC directly or from Authorized MCC Distributors are genuine parts, have full traceability, meet MCC's quality standards for handling and storage. **MCC will not provide any warranty coverage or other assistance for parts bought from Unauthorized Sources.** MCC is committed to combat this global problem and encourage our customers to do their part in stopping this practice by buying direct or from authorized distributors.